

## GK Series

### Dual Entry Key Operated Safety Interlock Switch

#### FEATURES

- Side or top key entry
- Unique friction feature for key retention
- LED Indicators for status available
- Choice of four heavy duty keys
- Standard mounting per EN 50041
- International conduit offering
- Positive opening operation of Normally Closed contacts conforming to IEC/EN 60947-5-1-3
- Available with 2 NC/2 NO, 3 NC/1 NO and 4 NC positive opening contact options
- UL listed, CSA and CE

#### BENEFITS

- Allows up to eight different key entry positions
- Door vibration does not trip the safety circuit
- Remote signalling can be achieved easily at the switch
- Key mounting flexibility and security
- Simple mounting
- Machinery can use local termination standards
- Welded contacts will separate - vital for safety applications
- Choice of wiring capabilities (switching inductive and safety relay loads)



(Pending)

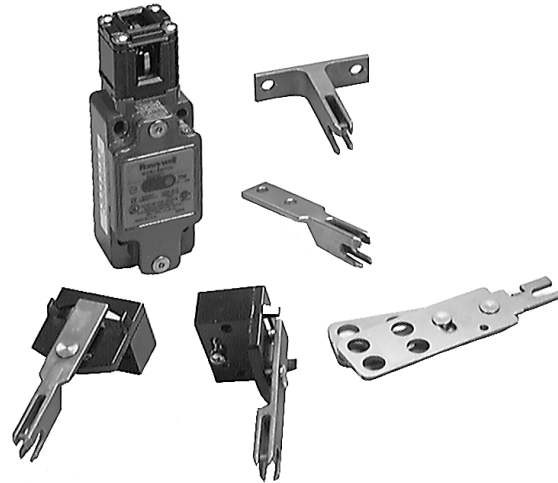

The GK Series is designed specifically for use on machines where key removal brings the machine to an immediate safe condition. It provides enhanced operator safety when added to hinged or sliding guard doors, screens and protective covers on enclosures. The GK Series is especially well suited for large door applications, typically in the automotive plant floor environment. Its heavy duty construction withstands harsh industrial environments where rugged, long-term durability is required.

Nearly 1000 options are available in a simple to understand part number tree.

A safety lockout device is also available for use with the GK Series. The lockout device (GKZL2) is specifically designed to prevent a key from being inserted either manually, or by the access door being closed while maintenance personnel are working on the machine. When inserted, the lockout device can accommodate up to four padlocks to prevent unauthorised removal of the device.

#### **WARNING**

##### MISUSE OF DOCUMENTATION

- The information presented in this product sheet (or catalogue) is for reference only. DO NOT USE this document as system installation information.
- Complete installation, operation and maintenance information is provided in the instructions supplied with each product.

Failure to comply with these instructions could result in death or serious injury.

## GKB- Metal Standard

GKC - (w/1 LED)

12...250 Vac/dc

GKD - (w/2 LED)

18...30 Vdc - EN 50041

**GK**

### Technical Data

<b>Mechanical life</b>	up to 15 million operations
<b>Degree of protection</b>	IP 67 NEMA/UL type 1, 4, 12, 13
<b>Temperature range</b>	<i>Operating:</i> -25 °C to +85 °C / -13 °F to +185 °F <i>Storage:</i> -40 °C to +85 °C / -40 °F to +185 °F
<b>Approvals*</b>	IEC 60947-5-1 EN 60947-5-1 Ac15 A300/A600 Dc13 Q300 UL & CSA
<b>Operating forces:</b>	Insertion force: 35 N / 8 lb Extraction force: 28 N / 6 lb Max. solenoid locking force: 1000 N / 224 lb
<b>Vibration</b>	10 g conforming to IEC 68-2-6
<b>Shock</b>	50 g conforming to IEC 68-2-27 Terminal marking to EN 50013

\* See Standards (page 179)

Dimensions in mm / in

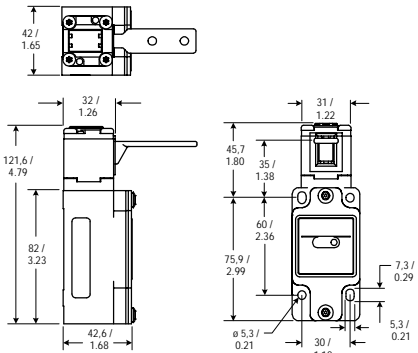

### Conduit Thread

Standard = <b>B</b>	<b>A</b> = 1/2" NPT
(w/1 LED) = <b>C</b>	<b>B</b> = PG 13,5
(w/2 LEDs) = <b>D</b>	<b>C</b> = 20 mm
	<b>D</b> = PF 1/2

Ordering:

**GK** **X** **X** **X** OR **XX**

Example: GKBB16N8

### Switch Type

Snap-action contacts, 1 Normally Closed/1 Normally Open

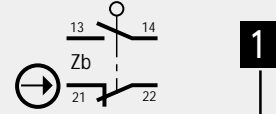

**1**

Slow Acting, break before make (BBM), 1 Normally Closed/1 Normally Open

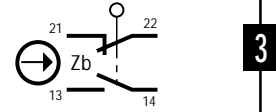

**3**

Slow Acting, 2 Normally Closed

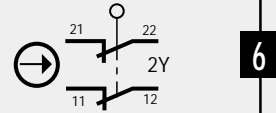

**6**

Slow Acting, 4 Normally Closed

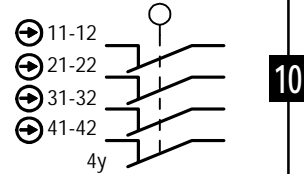

**10**

Slow Acting, 2 Normally Closed/2 Normally Open

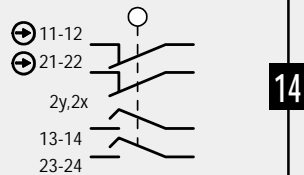

**14**

Slow Acting, 3 Normally Closed/1 Normally Open

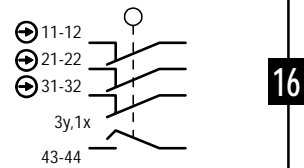

**16**

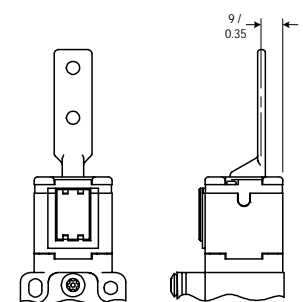
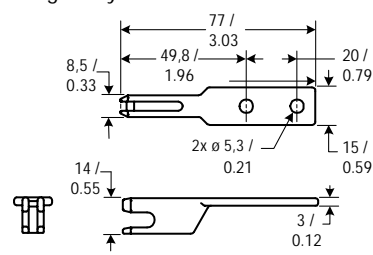
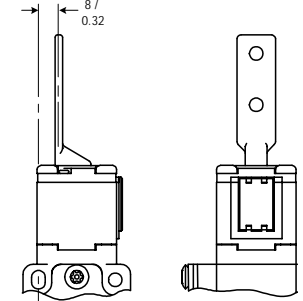
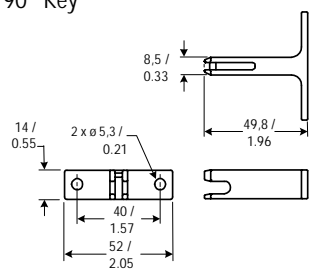
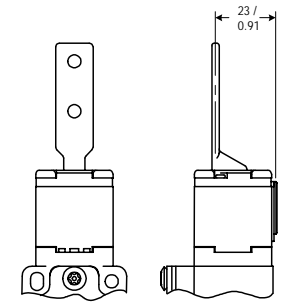
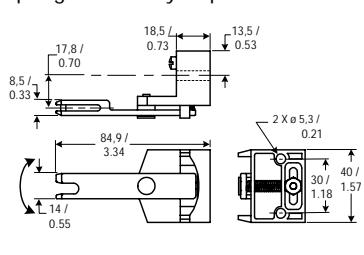
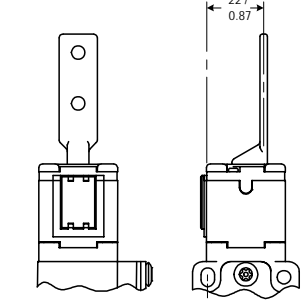
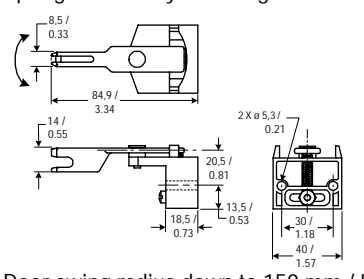
Head Orientation	Key Type
 <p style="text-align: right;"><b>L</b></p>	<p><b>Straight Key</b></p>  <p>Replacement part number GKZ56 <b>6</b></p> <p>Door swing radius down to 250 mm / 9.84 in</p>
 <p style="text-align: right;"><b>M</b></p>	<p><b>90° Key</b></p>  <p>Replacement part number GKZ57 <b>7</b></p> <p>Door swing radius down to 250 mm / 9.84 in</p>
 <p style="text-align: right;"><b>N</b></p>	<p><b>Spring-loaded Key: Up/Down</b></p>  <p>Replacement part number GKZ58 <b>8</b></p> <p>Door swing radius down to 150 mm / 5.9 in</p>
 <p style="text-align: right;"><b>P</b></p>	<p><b>Spring-loaded Key: Left/Right</b></p>  <p>Replacement part number GKZ59 <b>9</b></p> <p>Door swing radius down to 150 mm / 5.9 in</p>
<b>X</b>	<b>X</b>



# Accessories

The GKZL2 lockout device is for use with both the GK and GKR/GKL Series Dual Entry Head products. The lockout device does not activate the switch. It is designed to prevent a key from being inserted either manually, or by the access door being closed while maintenance personnel are working on the machine. When inserted, the lockout device accomodates up to four padlocks to prevent unauthorised removal of the device



Mounting dimensional diagram (mm/in):

